

Product user manual

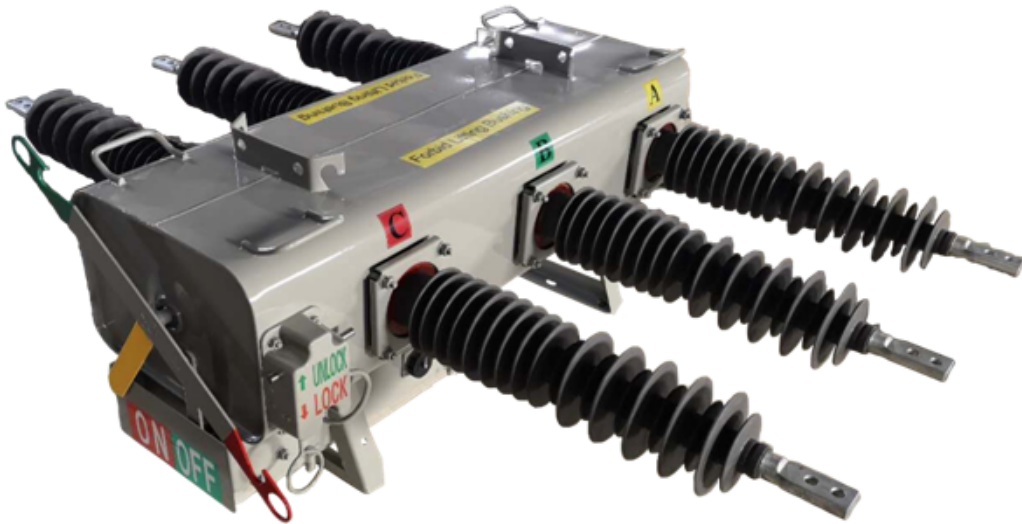

ZHUHAI GOPOWER SMART GRID CO., LTD

1. Normal service conditions

1.1 Ambient temperature

1.2 Ambient air temperature: Upper limit +50 °C Lower limit -40 °C

1.3 Relative humidity: 110%

1.4 Elevation not over 3000m.

1.5 Wind pressure not exceeding 700pa (wind speed 34m/s).

1.6 Earthquake intensity: 8 degree.

1.7 Installation site: No fire, no explosion. No chemical corrosion and frequent violent vibration.

1.8 Pollution classes: Class III, class IV.

The switch is made of proven durable, corrosion-resistant material. (304L stainless steel plate for warships), Ensure a long service life (30years), And can carry out a series of operations, with the pole top equipment ideal characteristics.

2. Standard

2.1 Each switch has been filled with sf6 gas before leaving the factory, sealed treatment, The test was carried out according to IEC60265-1 (1988) GB 3804-1990 standard.

2.2 Type of FWX.

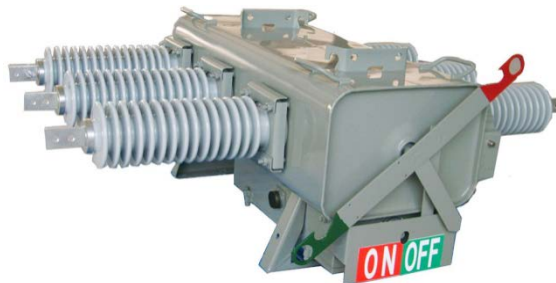

Rubber split casing outlet

2.3 Switch body

2.4 SF6 Gas Insulation switch is a Three-phase Linkage switch device, it is designed for segmented application for cable of distribution systems and overhead power lines. It can be operated manually or remotely in the control center.

2.5 Welding seal for switch housing, Rubber ring seals for casing and shell, All parts are assembled in welded stainless steel case

2.6 The switch shell is designed to withstand internal pressure without affecting the normal operating performance of the switch.

2.7 Shell made of cold rolled stainless steel over 3mm (SUS304L) or better material, To withstand internal gas pressure. And the shell use outdoor resin anticorrosive treatment

3 Construction of switch

3.1 Manual handle.

FWX operate safely with a high-voltage insulation rod, its structure can complete one-time operation on or off.

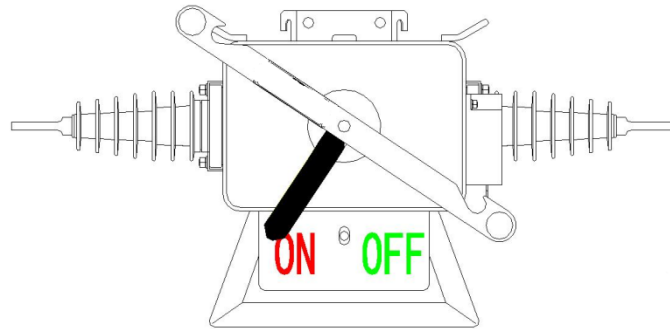

Table 9) Manual handle

3.2 Manual locking device

During blackout operation, to prevent the wrong operation of the switch。 During the operation, pull down the manual mechanical locking device and pull the ring to lock the switch mechanism in the position of "on" or "off", and the switch can no longer be operated when the switch is closed or opened. At the end of the operation, push up the manual mechanical locking device pull the ring to unlock the switch mechanism, the switch can be operated again. Ensure the reliability and safety of the operation.

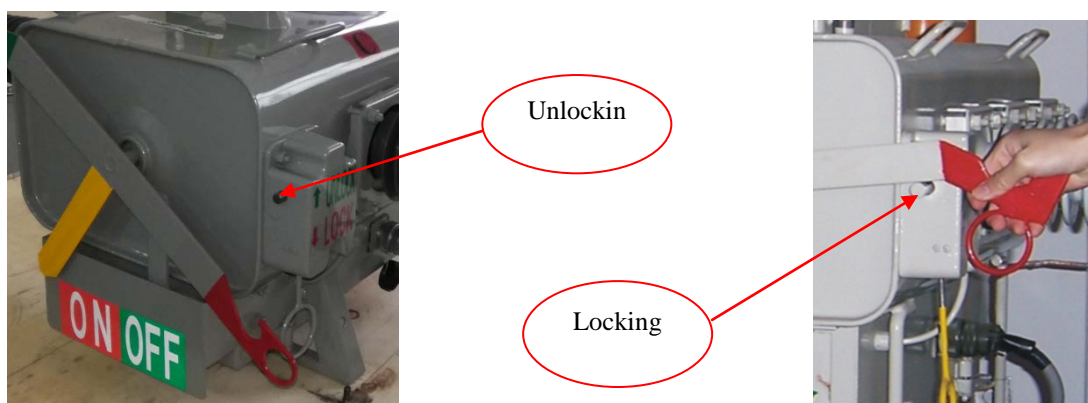

Table 11) Manual locking device

3.3 Contact position indicator

Standing on the ground, it is easy to see the color-marked position indication of the switch. (Green-Off; Red-On) .

3.4 Low pressure locking device

When the pressure drops to 0.02~0.04mpa, the automatic locking device is equipped to make the switch lock, which cannot be operated manually or electrically. At the same time, there are red alarm signs to alert.

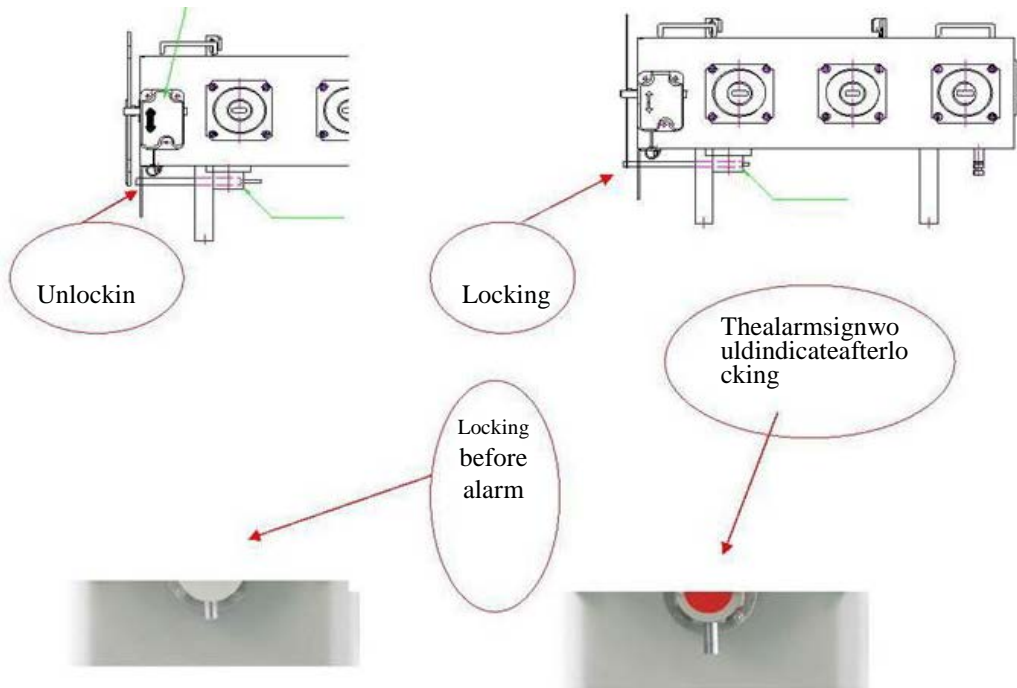

Table 12) Low pressure locking device

3.5 High pressure relief alarm device

In order to prevent the vessel from cracking when the gas pressure rises sharply due to the internal abnormality of the switch, a high pressure explosion proof and pressure relief device is specially installed. Pressure relief film actuated at 0.4mpa - 0.6mpa pressure , releasing internal pressure. High pressure explosion-proof pressure relief device is installed in the opposite direction of the hand handle to avoid pressure release film rupture endangering operator and public safety.

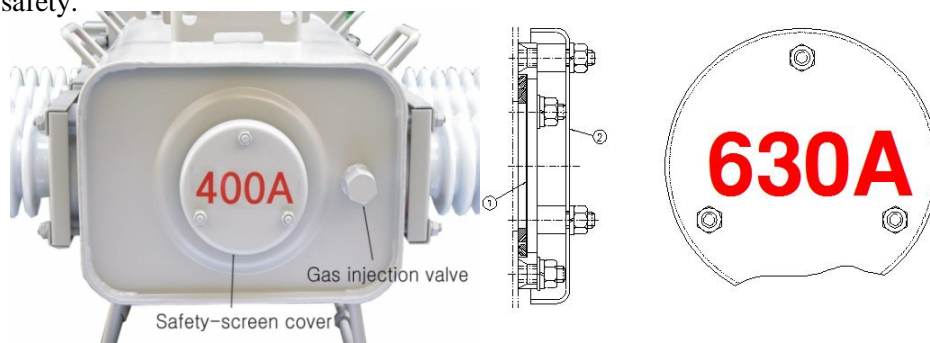

Table 13) High pressure relief alarm device

3.6 Lifting eye

The top of the main box has four special lifting eye and four handles for easy handling and hoisting.

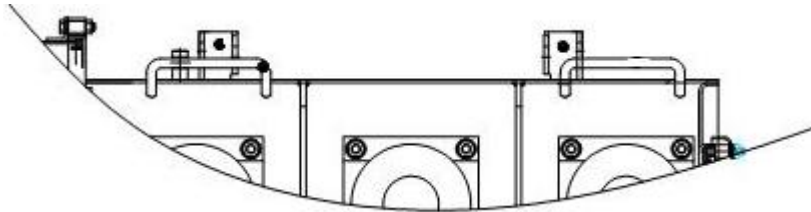

Table 15) Lifting eye

3.7 External connection terminal

When the terminal type is adopted, the connection terminal is copper tin plated, connected with the equipment clamp of the busbar, the lap surface of the outlet terminal is 76mm × 40mm, the section allowable current is 630A.

In /out line connection diagram

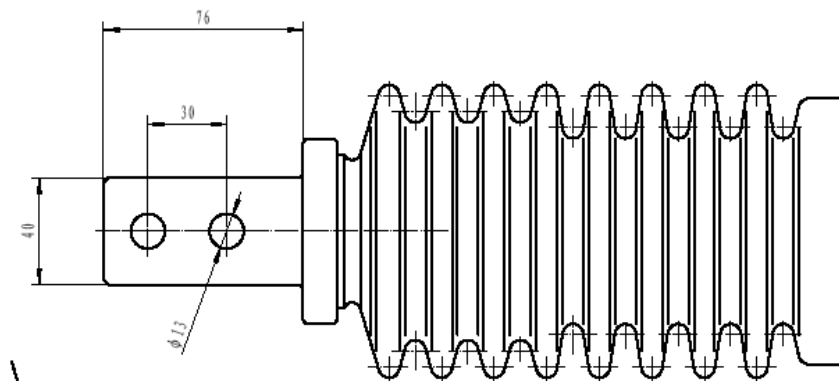

Table 21) Terminal connection indication



Table 22) Insulation through wiring diagram

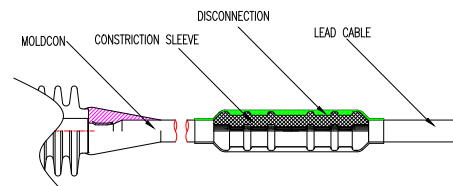

Table 23) Pressing sleeve

4. Product installation

① Pre-installation confirmation

Opened the packing, check the packing list and product parts to confirm if match.;

Check the appearance of the switch by eye to confirm whether the porcelain sleeve, closing / closing indicator, manual handle, gas pressure gauge, etc., are damaged or abnormal; When there is a gas pressure gauge in the body, read the gauge to confirm that it is within the normal gas range (standard pressure $\pm 0.01\text{MPa}$);

Manual operating closing / opening 5 times;

After the above procedure, the installation begins when there is no abnormal;

✘After open the package, please do not lift the porcelain sleeve or handle when handling the switch. Be sure to use a hook or handle (above the body), abnormal performance will occur when handling with a porcelain sleeve or handle.

② Installation essentials

Install switches in the following order and essentials.

Install upper and lower hoops on the poles.

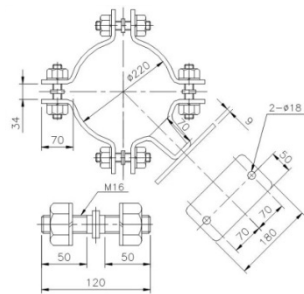

Hanger anchor ear

Please refer to the assembly diagram below to install the bracket.

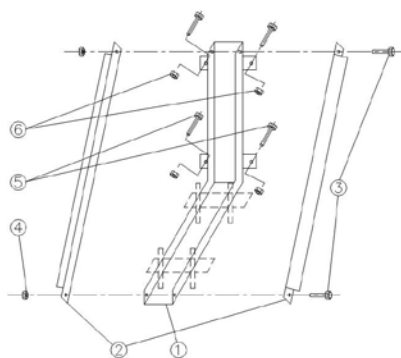

No.	Name	Q't	Material	Size
1	Bracket	1	SS41B	5t×100
2	Cross arms	2	SS41	6t×50×1029
3	Bolt	2	Steel	M16×150
4	Nut	2	Steel	M16
5	Bolt	4	Steel	M16×40
6	Nut	4	Steel	M16

Mounting bracket drawing

Insert the bolt on the hole above the switch

Assemble mounting bracket and galvanized plate, cover on top of switch, flat pad and screw fixing.

Use the hook on the top of the switch to lift the switch to the installation position.

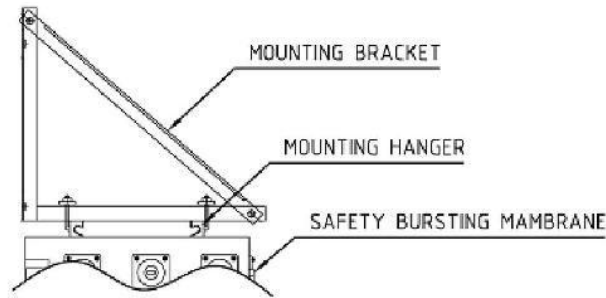

After adjusting the level of the switch body, the upper hanger hoop, the lower hanger hoop firmly fixed with the mounting support.

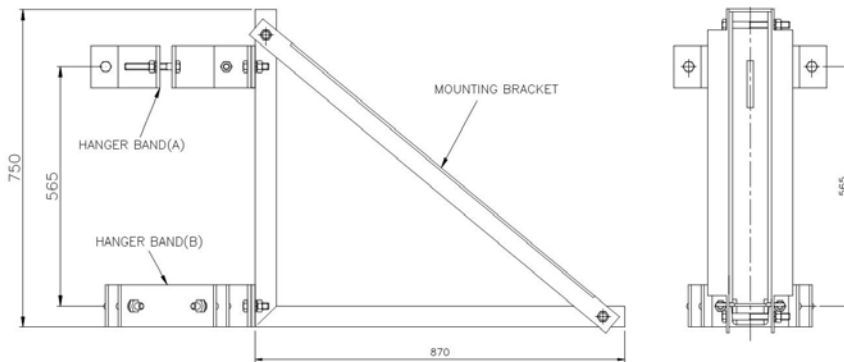

Mounting drawing of bracket

Install the control box on the pole;

Connect the ground wire to the ground terminal of the switch and control box;

Switch and control box are connected with control cables;

Confirm that the closing / opening indicator is normal.

Use the closing / opening button of the control box to operate the closing / opening about 5 times.

4.1 Switch hoist installation

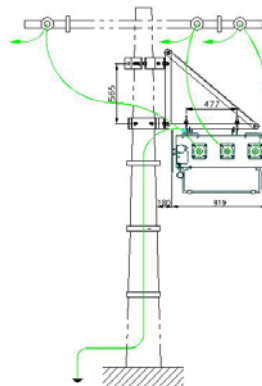

4.2 Switch seat type installation

